

## Installation Instructions

### uridan<sup>®</sup> non water trough, type GR-1800.

Installation of the uridan water free urinals is very simple. If you have earlier had water flush urinals, the drainpipe **should** be cleaned before installation of uridan urinals.

uridan<sup>®</sup> urinals work without water, and therefore should only be connected with  $\varnothing$  50 mm drainpipe. Installation should be carried out by authorized plumbers.

1. Fix bracket no. (8) with 2 screws of 8x80 mm, the trough hangs on this bracket.
2. Fix the screen with 4 screws of 8x60 mm.
3. Slide the trough down over bracket no.8 ensuring the waste trap is secure.
4. Insert the small PVC pipe (B) in the water lock and afterwards pour approximately 1 litre water.
5. Insert the stainless steel cover (A).
6. Then pour 1 bottle – 0,3 litre urilock fluid over the cover.
7. Apply silicon sealant between the trough and the wall.

The urinal is ready for use now!

**Important: Never pour urilock<sup>®</sup> fluid before the stainless steel cover is insert.**

Please give the attached cleaning instructions, uriclean and hook to the customer.

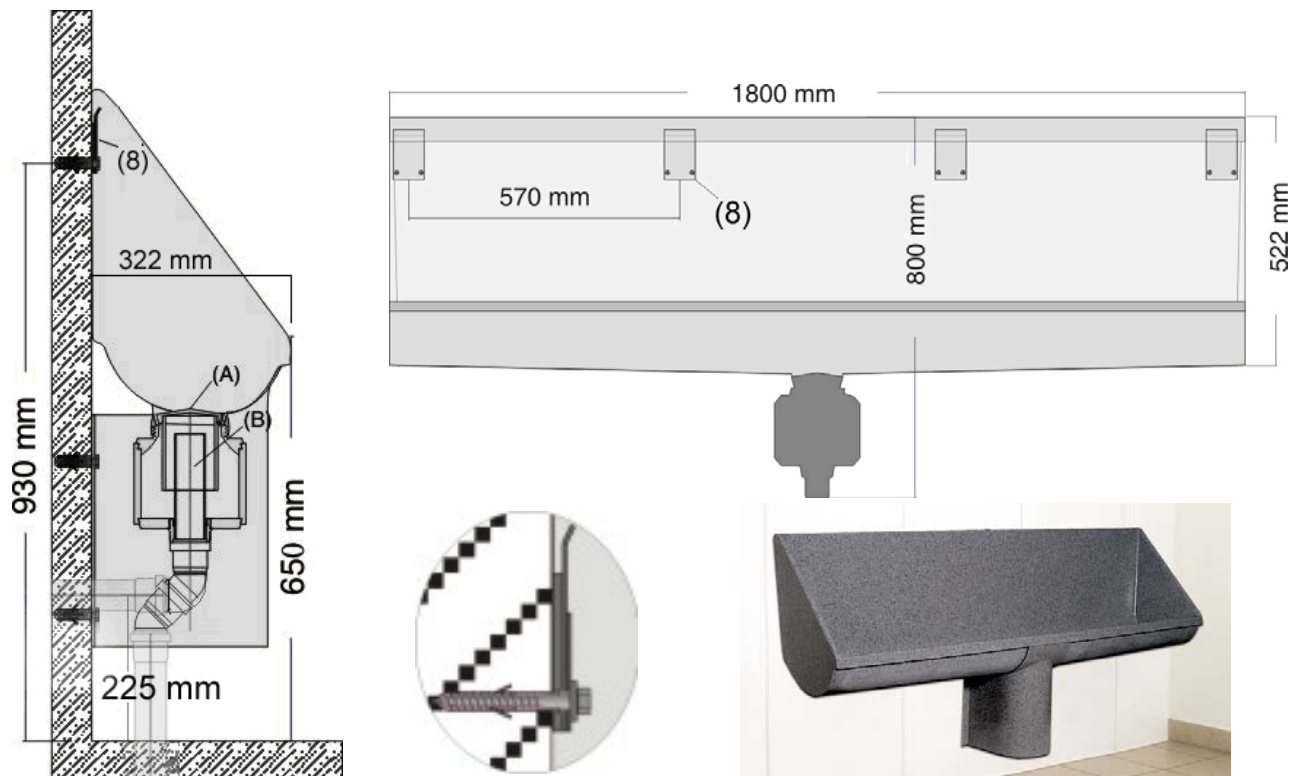

uridan<sup>®</sup> non water troughs can be used for both horizontal and vertical drainpipe. In case of horizontal installation, the distance from the floor to the centre of the drainpipe should be 225 mm.